



8



2



1



12



12



14



4



1



1



Diversa Sp. z o.o.  
ul. Krasnowolska 50, 02-849 Warszawa  
Zakład w Prudniku:  
ul. Prężynska 23, 48-200 Prudnik  
tel. (+48) 77 435 41 11  
e-mail: b.uro@diversa.com.pl  
www.diversa.info.pl

Instrukcja montażu — Bauanleitung — Assembly instrucion — Instrukce — Instruction de montage — Istruzione di montaggio — Instruccio de montaje

# AQUATIC

60x30x90  
60x40x90

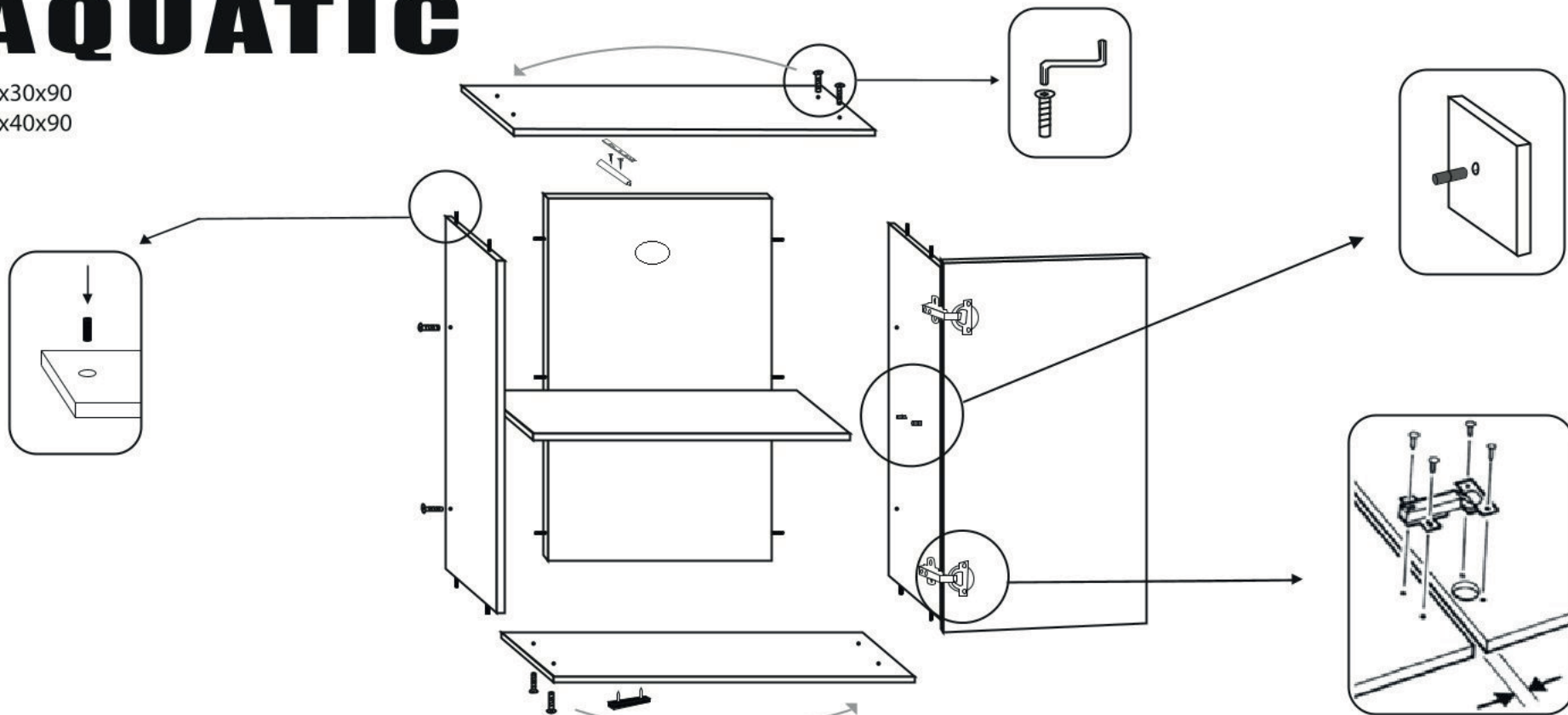

- 1
- 2
- 3
- 4
- 5
- 6

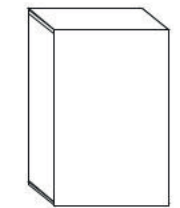
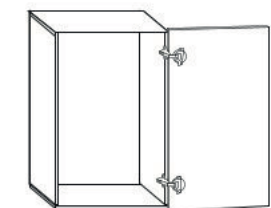
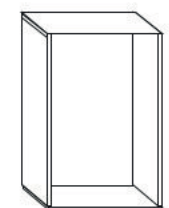
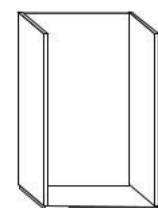
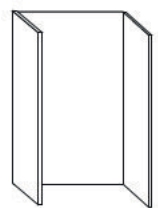
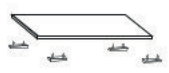



10

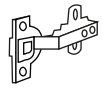

4

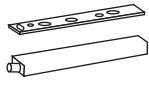

2



22



20



25



4

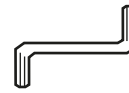

1



Diversa Sp. z o. o.  
 u. Krasnowolska 50, 02-849 Warszawa  
 Zakład w Prudniku:  
 ul. Prężyńska 23, 48-200 Prudnik  
 tel. (+48) 77 436 41 11  
 e-mail: biuro@diversa.com.pl  
 www.diversa.info.pl

Instrukcja montażu – Bauanleitung – Assembly instruction – Instrukce – Instruction de montage – Instruzione di montaggio – Instruccio de montaje

# AQUATIC

90x60x90

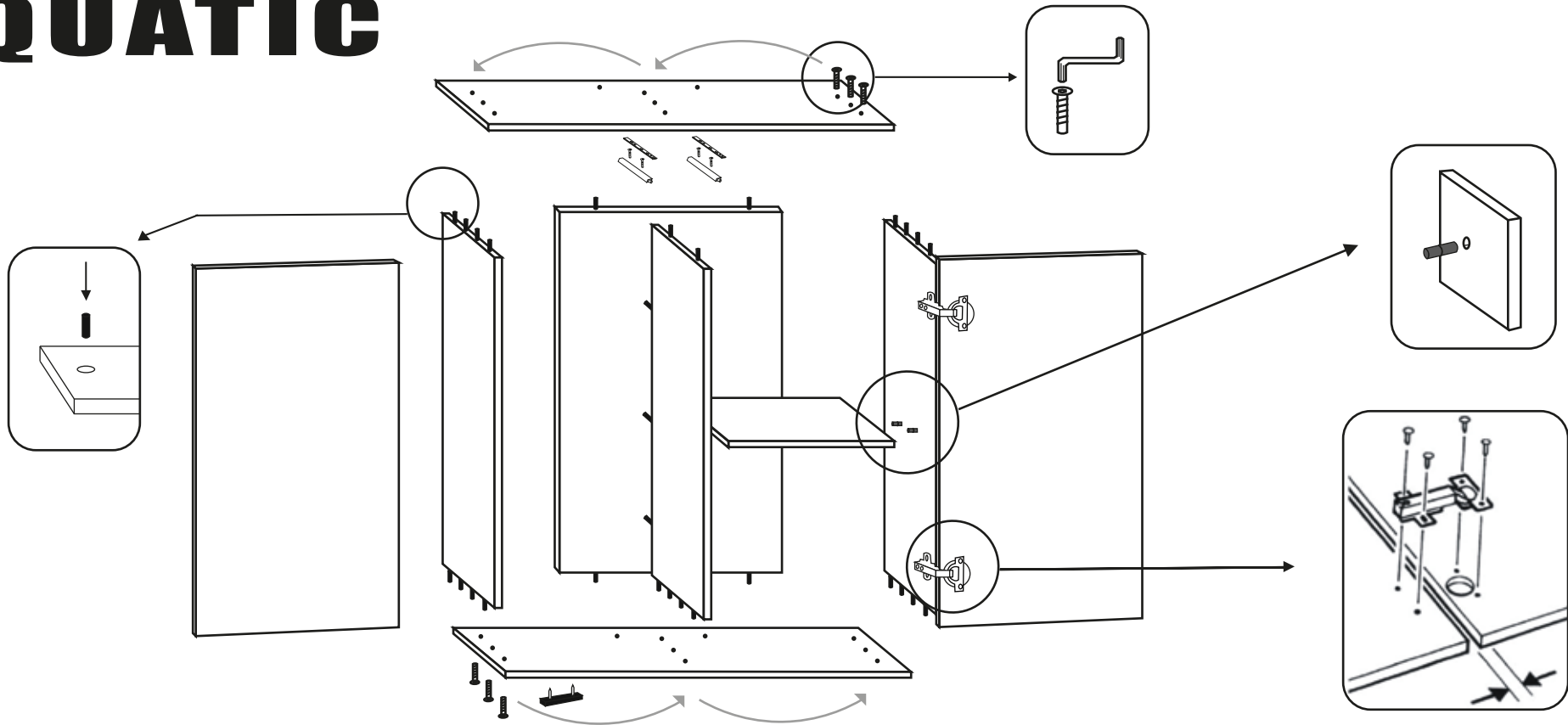

1

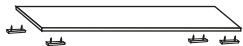

2

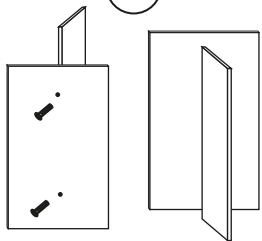

3

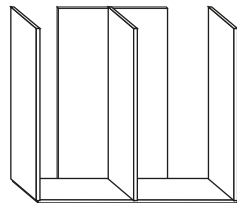

4

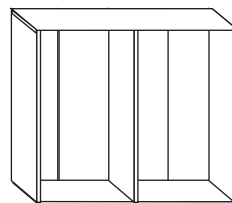

5

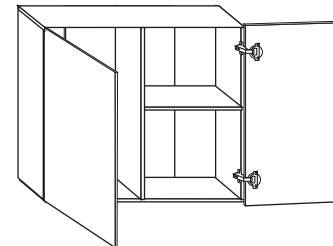

6

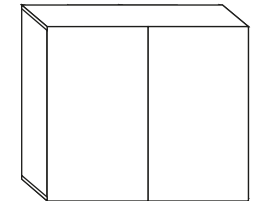

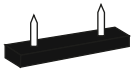

10

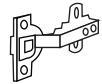

4

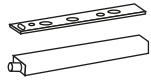

2



18



20

80x35  
100x40 -21  
90x45  
100x50 -27  
100x60



4



1

**diversa**  
Pet Products

Diversa Sp. z o. o.  
u. Krasnowolska 50, 02-849 Warszawa  
Zakład w Prudniku:  
ul. Prężyńska 23, 48-200 Prudnik  
tel. (+48) 77 436 41 11  
e-mail: biuro@diversa.com.pl  
www.diversa.info.pl

Instrukcja montażu – Bauanleitung – Assembly instrucion – Instrukce – Instruction de montage – Istruzione di montaggio – Instruccio de montaje

# AQUATIC

80x35x90  
90x45x90  
100x40x90  
100x50x90  
100x60x90

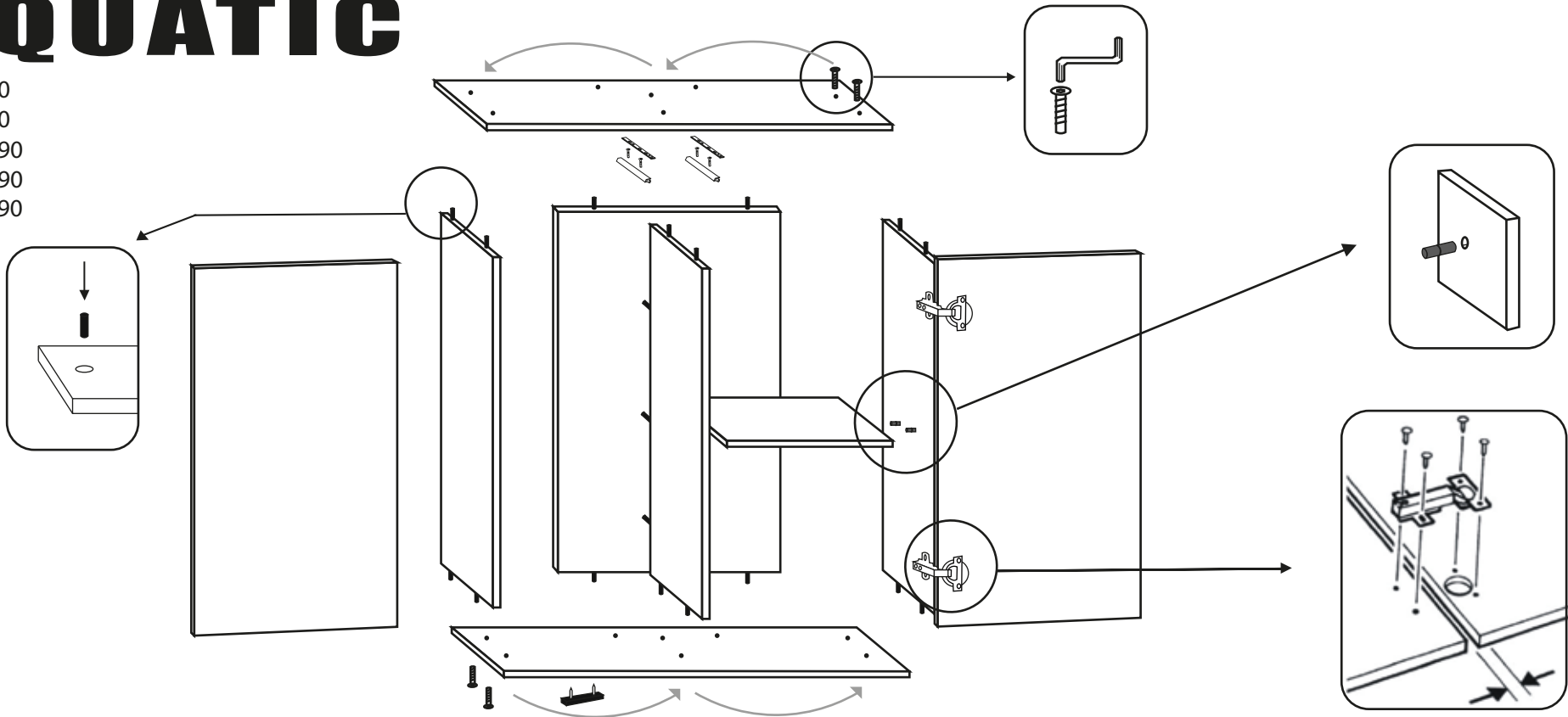

1



2

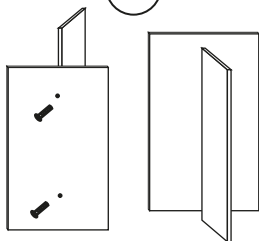

3

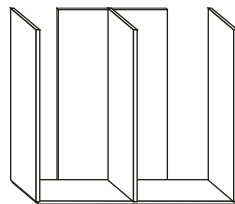

4

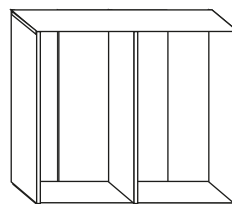

5

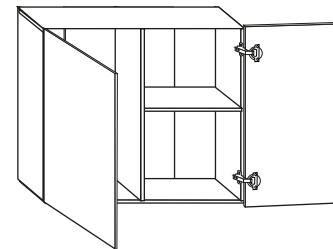

6

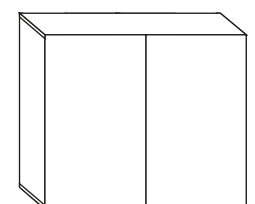

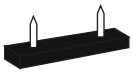

12



6

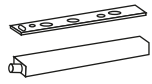

3



36



30



120x60  
160x60  
150x60 -38



8



1



Diversa Sp. z o. o.  
u. Krasnowolska 50, 02-849 Warszawa  
Zakład w Prudniku:  
ul. Prężyńska 23, 48-200 Prudnik  
tel. (+48) 77 436 41 11  
e-mail: [biuro@diversa.com.pl](mailto:biuro@diversa.com.pl)  
[www.diversa.info.pl](http://www.diversa.info.pl)

Instrukcja montażu — Bauanleitung — Assembly instrucion — Instrukce — Instruction de montage — Istruzione di montaggio — Instruccio de montaje

# AQUATIC

120x60x90  
150x60x90  
160x60x90

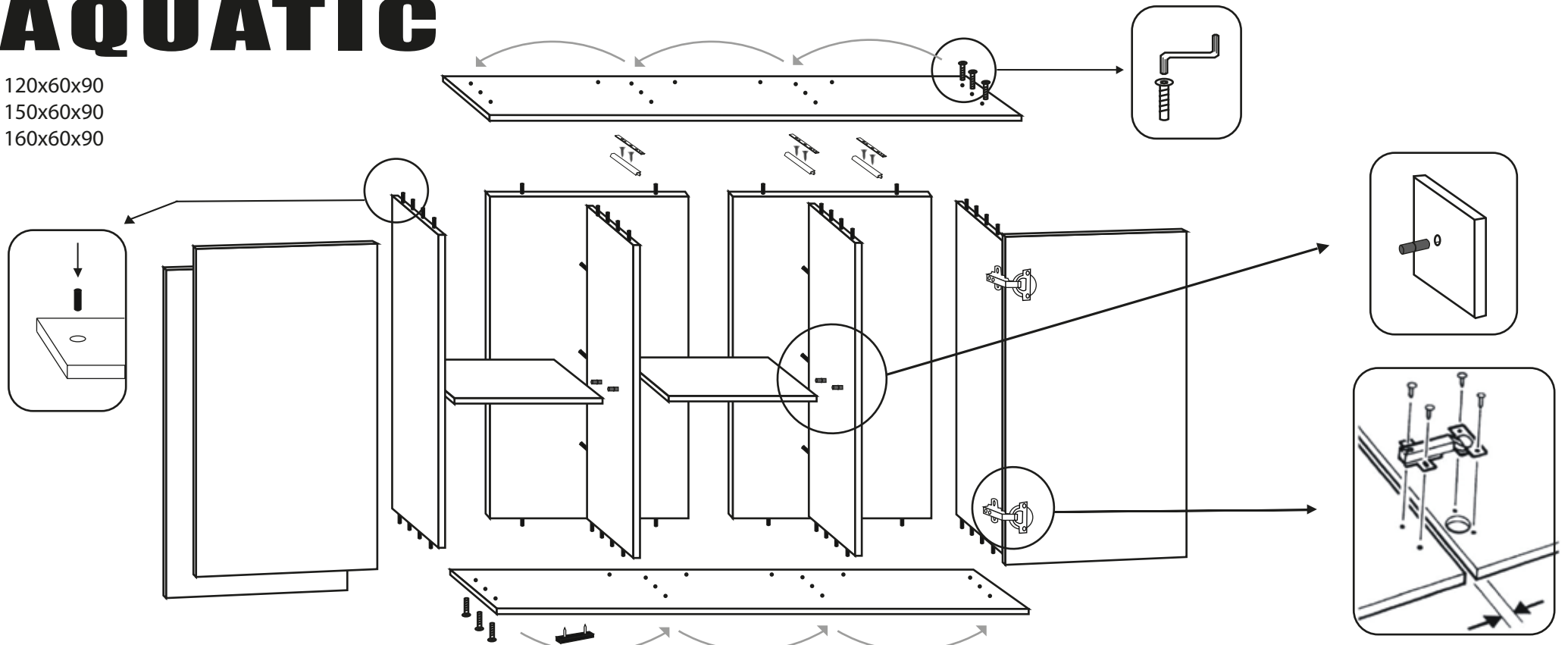

1

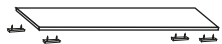

2

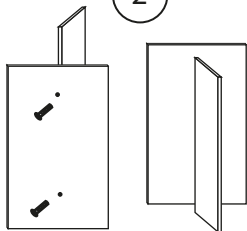

3

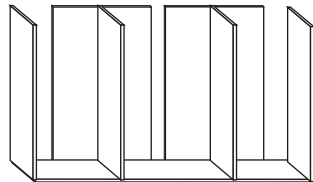

4

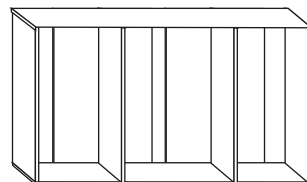

5

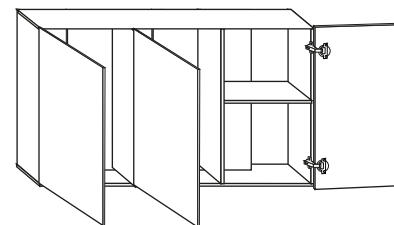

6

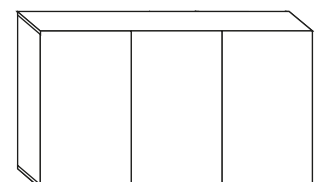



12

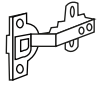

6

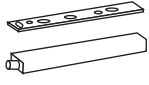

3



28



30



120x50  
150x50 -42  
120x40 -38



8

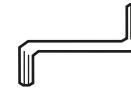

1



Diversa Sp. z o. o.  
u. Krasnowolska 50, 02-849 Warszawa  
Zakład w Prudniku:  
ul. Preżyńska 23, 48-200 Prudnik  
tel. (+48) 77 436 41 11  
e-mail: biuro@diversa.com.pl  
www.diversa.info.pl

Instrukcja montażu — Bauanleitung — Assembly instruction — Instrukce — Instruction de montage — Istruzione di montaggio — Instruccio de montaje

# AQUATIC

120x40x90  
120x50x90  
150x50x90

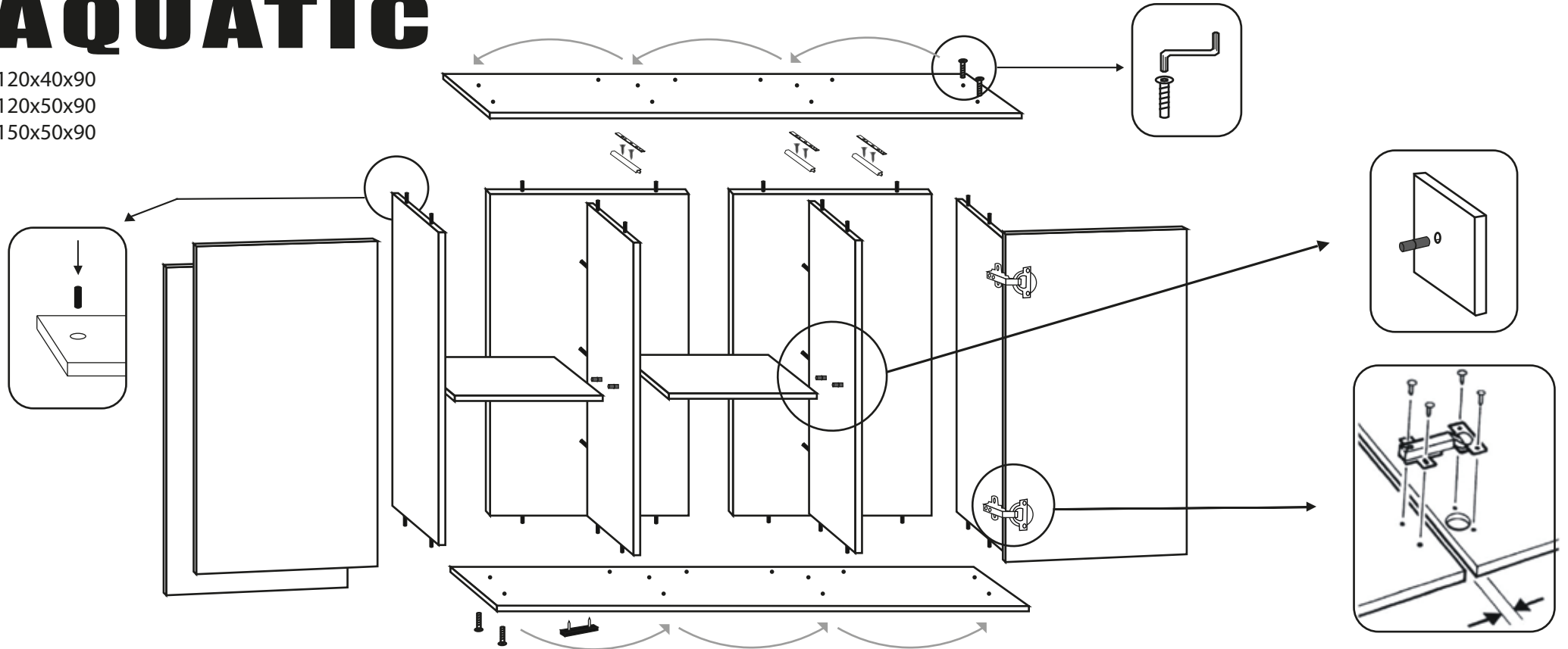

1



2

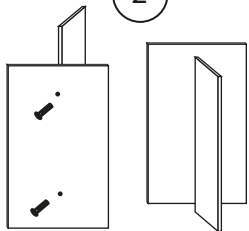

3

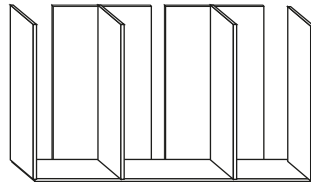

4

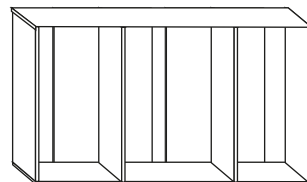

5

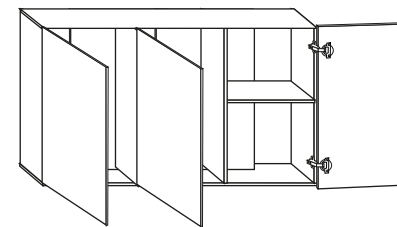

6

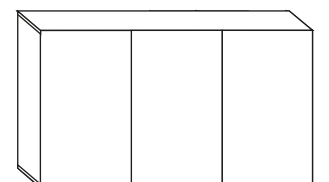



18

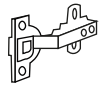

8

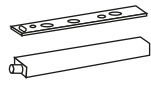

4



-48



40



200x60  
200x80 -77



8



1



Diversa Sp. z o. o.  
u. Krasnowolska 50, 02-849 Warszawa  
Zakład w Prudniku:  
ul. Prężyńska 23, 48-200 Prudnik  
tel. (+48) 77 436 41 11  
e-mail: [biuro@diversa.com.pl](mailto:biuro@diversa.com.pl)  
[www.diversa.info.pl](http://www.diversa.info.pl)

Instrukcja montażu — Bauanleitung — Assembly instrucion — Instrukce — Instruction de montage — Istruzione di montaggio — Instruccio de montaje

# AQUATIC

200x60x90  
200x80x90

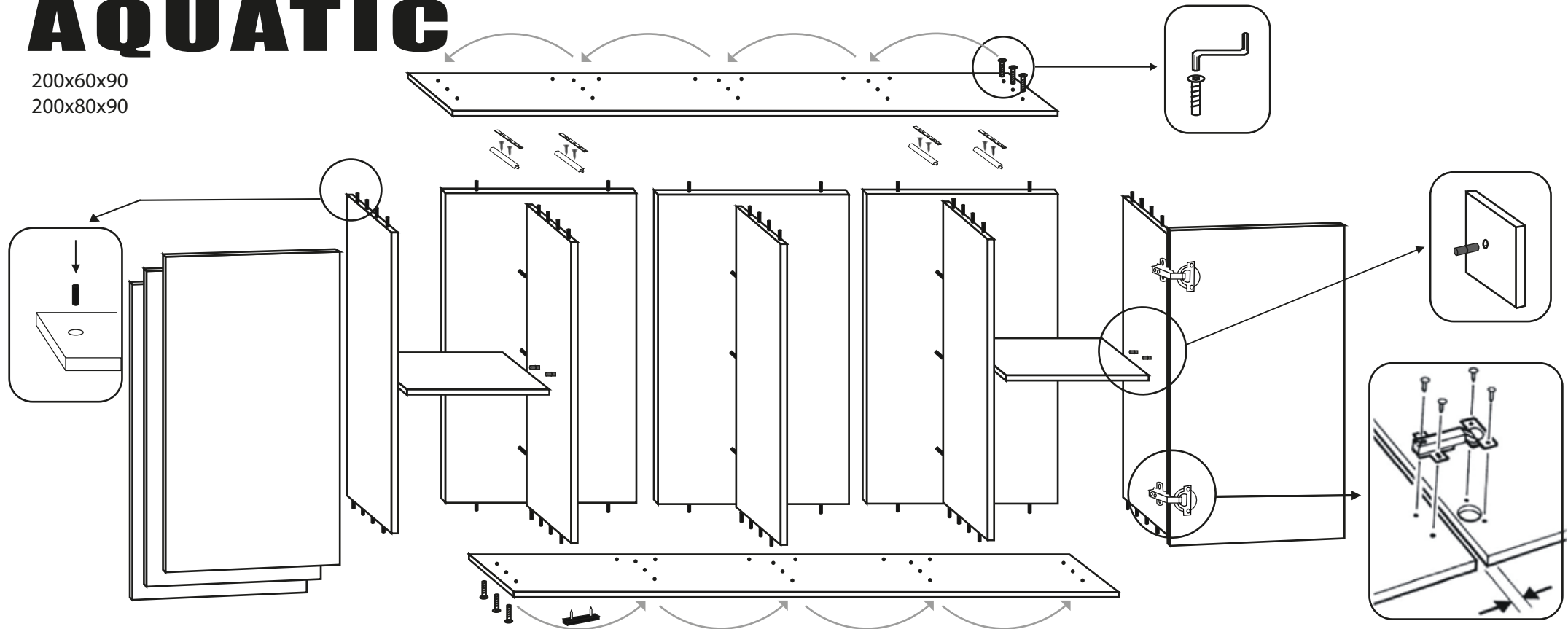

1

2

3

4

5

6

